

Partition Mounted

B-357 CLASSIC SERIES SEAT-COVER DISPENSER, SANITARY NAPKIN DISPOSAL AND TOILET TISSUE DISPENSER

Mounts centered through toilet partition. Used from both sides, serviced from one side. Capacity: 0.8-gal. (3.0-L). Holds 1000 toilet seat covers and four rolls of tissue, two for each compartment. Theft-resistant spindles. Rough Partition Opening: 15 1/2" W, 28 7/8" H (395 x 735mm). Av. Mtg. Ht.: 60" (1525mm) to top of unit.



B-357

B-3471 CLASSIC SERIES SEAT-COVER DISPENSER AND TOILET TISSUE DISPENSER

One side mounts flush against partition of Barrier-Free compartment to allow clearance for grab bar. Used from both sides, serviced from one side. Holds 1000 toilet seat covers and four rolls of tissue, two for each compartment. Theft-resistant spindles. Rough Partition Opening: 15 1/2" W, 28 7/8" H (395 x 735mm). Universal/Barrier-Free Mtg. Ht.: 43 1/4" (1100mm) to top of unit.



B-3471

- Partition Mounted Models B-347, B-3471, B-357, B-3571 mount through partitions 1/2" to 2" (13–51mm) thick, serving two compartments.
- Models B-3471, B-3474, B-3571, B-3574 meet Barrier-Free accessibility guidelines.
- Toilet tissue dispensers accommodate 5 1/4" (135mm) diameter, 1800-sheet rolls.
- Flanges are one-piece seamless, doors secured with full-length stainless steel hinges, and tumbler locks keyed like other Bobrick models.
- Constructed of type 304 stainless steel throughout with satin finish on all exposed surfaces; welded construction.
- Theft-resistant spindles included.

B-3571 Similar to B-357, but one side mounts flush against partition of Barrier-Free compartment to allow clearance for grab bar. Universal/Barrier-Free Mtg. Ht.: 43 1/4" (1100mm) to top of unit.

B-3574 Similar to B-3571, but for recessed installation in side wall of single compartment. Rough Wall Opening: 16" W, 29 1/4" H, 4" min. depth (405 x 745 x 102mm). Av. Mtg. Ht.: 60" (1525mm) to top of unit; Barrier-Free, 43 1/4" (1100mm).

B-3579 Similar to B-3574, but with stainless steel skirt for surface mounting. Av. Mtg. Ht.: 60" (1525mm) to top of unit.

B-347 Similar to B-3471, but mounts centered through toilet partition. Av. Mtg. Ht.: 60" (1525mm) to top of unit.

B-3474 Similar to B-3471, but for recessed installation in side wall of single compartment. Rough Wall Opening: 16" W, 29 1/4" H, 4" min. depth (405 x 745 x 102mm). Av. Mtg. Ht.: 60" (1525mm) to top of unit; Barrier-Free, 43 1/4" (1100mm).

B-3479 Similar to B-3474, but with stainless steel skirt for surface mounting. Av. Mtg. Ht.: 60" (1525mm) to top of unit.

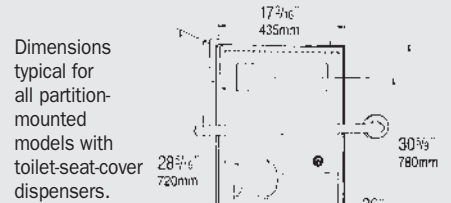

DESIGNER'S NOTES

1. Partition-mounted units B-3471, B-3571 with one side flush to partition of Barrier-Free compartment have toilet tissue on left when facing unit.

2. Recessed units B-3474, B-3574 and surface-mounted units B-3479, B-3579 have toilet tissue on right when facing unit.

3. Rear edge of partition cutout should be 20 1/2" (520mm) from back wall. This will locate toilet tissue within 12" (305mm) of front of a standard

toilet that projects 30" (760mm) from back wall.

4. Cutouts in partitions for accessories can be pre-cut at factory if location and size of cutouts are specified and orders for both partitions and accessories are received together.

Recessed

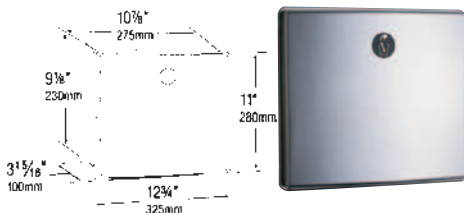

B-4353 CONTURA SERIES SANITARY NAPKIN DISPOSAL Satin-finish stainless steel. Self-closing door pulls down for access to disposal. Furnished with removable, leak-proof, 1.2-gal. (4.6-L) plastic receptacle. Rough Wall Opening: 11 1/4" W, 9 1/2" H, 4" min. depth (285 x 240 x 102mm). Universal/Barrier-Free Mtg. Ht.: 31" (785mm) to top of unit. Patented.

B-35303 TRIMLINE SERIES SANITARY NAPKIN DISPOSAL Satin-finish stainless steel. Door has 90° return, conceals flange. Self-closing panel covers disposal opening. Removable, leak-proof, 1.2-gal. (4.6-L) plastic receptacle. Rough Wall Opening: 11 1/2" W, 17 3/4" H, 3 3/4" min. depth (290 x 440 x 95mm). Universal/Barrier-Free Mtg. Ht.: 31" (785mm) to top of unit.

B-3513 TRIMLINE SERIES SANITARY NAPKIN DISPOSAL Satin-finish stainless steel. Door has 90° return, conceals flange. Door pulls down to open. Removable, leak-proof, 0.6-gal. (2.3-L) plastic receptacle. Rough Wall Opening: 6" W, 12" H, 3 3/4" min. depth (150 x 305 x 95mm). Universal/Barrier-Free Mtg. Ht.: 31" (785mm) to top of unit.

BARRIER-FREE WASHROOM GUIDELINES

It is critical to consult state and local jurisdictions and accessibility codes to confirm compliance of horizontal and vertical mounting locations of individual and combination accessories within toilet compartments, including toilet tissue dispensers, toilet seat cover dispensers, sanitary napkin disposals and grab bars.

DESIGNER'S NOTE

When combination units are mounted in an accessible toilet compartment through the shared toilet partition panel, the unit's location in the adjoining toilet compartment must permit the unit's complete operation, and allow for the unit's door to swing clear of the toilet when custodians service the unit.

PRICE	Contura™ Series	1.8
	TrimLine™ Series	1.5
INDEX	Classic™ Series	1.0
	Matrix™ Series	0.6

Note: Price index is a comparison of toilet accessories for a typical washroom of popularly specified products. Product mix may affect Price Index comparisons.

Recessed

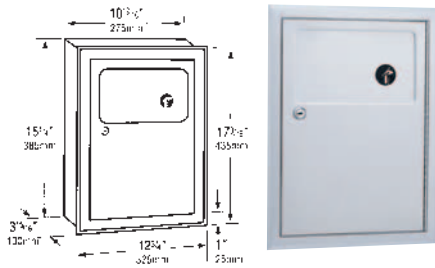

- B-353 CLASSIC SERIES SANITARY NAPKIN DISPOSAL** Satin-finish stainless steel. Seamless beveled flange. Door has tumbler lock. Self-closing panel covers disposal opening. Removable, leak-proof, 1.2-gal. (4.6-L) plastic receptacle. Rough Wall Opening: 11 1/4\" W, 15 5/8\" H, 4\" min. depth (285 x 395 x 102mm). Universal/Barrier-Free Mtg. Ht.: 31\" (785mm) to top of unit.

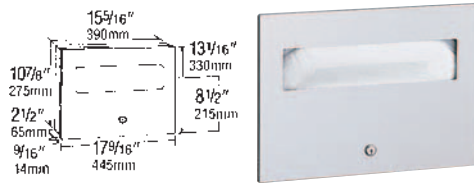

- B-3013 TRIMLINE SERIES SEAT-COVER DISPENSER** Satin-finish stainless steel. Door has 90° return, conceals flange. Dispenses 500 toilet seat covers. Rough Wall Opening: 15 5/8\" W, 11 1/4\" H, 2 3/4\" min. depth (395 x 285 x 70mm). Av. Mtg. Ht.: 60\" (1525mm) to top of unit; Barrier-Free, 49\" (1245mm).

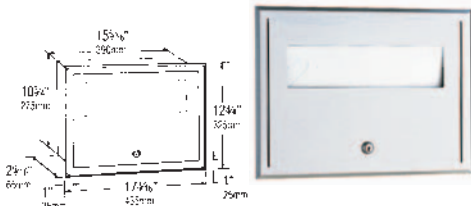

- B-301 CLASSIC SERIES SEAT-COVER DISPENSER** Satin-finish stainless steel. Seamless beveled flange. Dispenses 500 toilet seat covers. Rough Wall Opening: 15 5/8\" W, 11\" H, 2 5/8\" min. depth (395 x 285 x 67mm). Av. Mtg. Ht.: 60\" (1525mm) to top of unit; Barrier-Free, 49\" (1245mm).

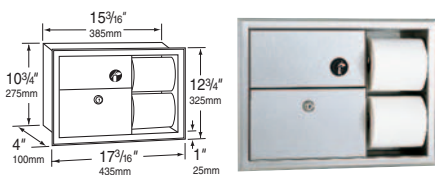

- B-3094 CLASSIC SERIES SANITARY NAPKIN DISPOSAL AND TOILET TISSUE DISPENSER** Satin-finish stainless steel. Disposal door is self-closing. Receptacle retained in cabinet by tumbler lock. Capacity: 3/4-gal. (2.8-L). Holds two rolls up to 5 1/4\" (135mm) dia. (1800 sheets). Rough Wall Opening: 15 5/8\" W, 11 1/4\" H, 4\" min. depth (395 x 285 x 102mm). Universal/Barrier-Free Mtg. Ht.: 30\" (760mm) to top of unit.

Theft-Resistant Spindle (Part No. 283-604) available as replacement part for above model. See page 33.

Partition Mounted

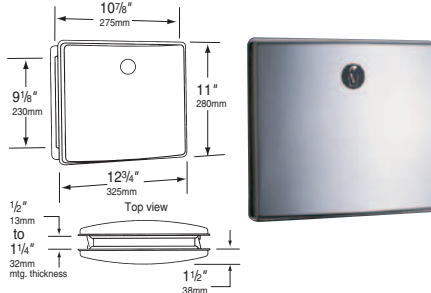

- B-4354 CONTURA™ SERIES SANITARY NAPKIN DISPOSAL** Satin-finish stainless steel. Mounts in toilet partition 1/2–1 1/4\" (13–32mm) thick. Self-closing doors pull down with less than 5 lb of force (22.2 N) for access to disposal. Removable, leak-proof, 0.7-gal. (2.7-L) plastic receptacle. Rough Partition Opening: 11\" W, 9 3/8\" H (280 x 240mm). Universal/Barrier-Free Mtg. Ht.: 31\" (785mm) to top of unit. Patented.

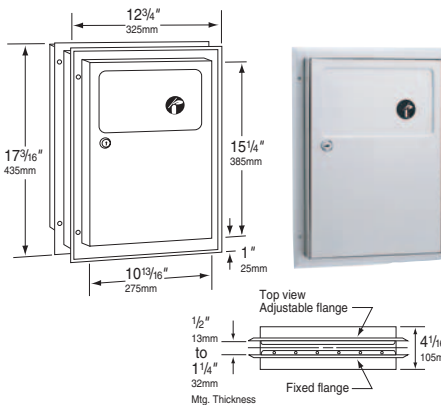

- B-354 CLASSIC SERIES SANITARY NAPKIN DISPOSAL** Satin-finish stainless steel. Mounts in partitions 1/2–1 1/4\" (13–32mm) thick. Self-closing panels cover openings. Removable, leakproof, 1.2-gal. (4.6-L) plastic receptacle. Rough Partition Opening: 11\" W, 15 1/2\" H (280 x 395mm). Universal/Barrier-Free Mtg. Ht.: 31\" (785mm) to top of unit.

Surface Mounted

- B-270 CONTURA SERIES SANITARY NAPKIN DISPOSAL** Satin-finish stainless steel. Cover is drawn, one-piece construction; secured to cabinet with full-length stainless steel piano-hinge. Unit 7 1/2\" W, 10\" H, 3 13/16\" D (190 x 255 x 95mm). Universal/Barrier-Free Mtg. Ht.: 25–30\" (635–760mm) to top of unit. Patented.



- B-254 CLASSIC SERIES SANITARY NAPKIN DISPOSAL** Satin-finish stainless steel. Door has tumbler lock. Self-closing panel covers disposal opening. Removable, leak-proof, 1.2-gal. (4.6-L) plastic receptacle. Unit 10 11/16\" W, 15 1/8\" H, 4 1/16\" D (270 x 385 x 105mm). Universal/Barrier-Free Mtg. Ht.: 30\" (760mm) to top of unit.



- B-5270 MATRIX SERIES SANITARY NAPKIN DISPOSAL** Durable ABS plastic; grey color. Lid features fingertip handles for easy access. Unit 9 1/4\" W, 11 3/8\" H, 3 7/8\" D (235 x 290 x 100mm). Universal/Barrier-Free Mtg. Ht.: 25–30\" (635–760mm) to top of unit. Patented.



- B-4221 CONTURA SERIES SEAT-COVER DISPENSER** Satin-finish stainless steel. Dispenses 250 single- or half-fold toilet seat covers. Fills from bottom. Unit 15 3/4\" W, 11 1/4\" H, 2 1/16\" D (400 x 285 x 55mm). Av. Mtg. Ht.: 45–49\" (1145–1500mm) to top of unit, Barrier-Free, 30–45\" (760–1145mm). Patented.



- B-221 CLASSIC SERIES SEAT-COVER DISPENSER** Satin-finish stainless steel. Dispenses 250 single- or half-fold toilet seat covers. Fills from bottom. Unit 15 3/4\" W, 11\" H, 2\" D (400 x 280 x 50mm). Av. Mtg. Ht.: 45–49\" (1145–1500mm) to top of unit, Barrier-Free, 30–45\" (760–1145mm).



- B-5221 MATRIX SERIES SEAT-COVER DISPENSER** Durable ABS plastic; grey color. Dispenses 250 single- or half-fold toilet seat covers. Fills from bottom. Unit 16 1/8\" W, 11 1/2\" H, 2 1/2\" D (410 x 290 x 65mm). Av. Mtg. Ht.: 45–49\" (1145–1500mm) to top of unit, Barrier-Free, 30–45\" (760–1145mm). Patented.



DISPOSABLE PAPER LINERS, 1000 PER CASE

Order Part No.:	For Model No.:
270-12	B-270, B-5270
3094-12	B-3094
353-12	B-254, B-353, B-35303, B-354, B-357, B-3571, B-3574, B-3579, B-4353, B-4354